

Sumitomo Bakelite

Polymer waveguide

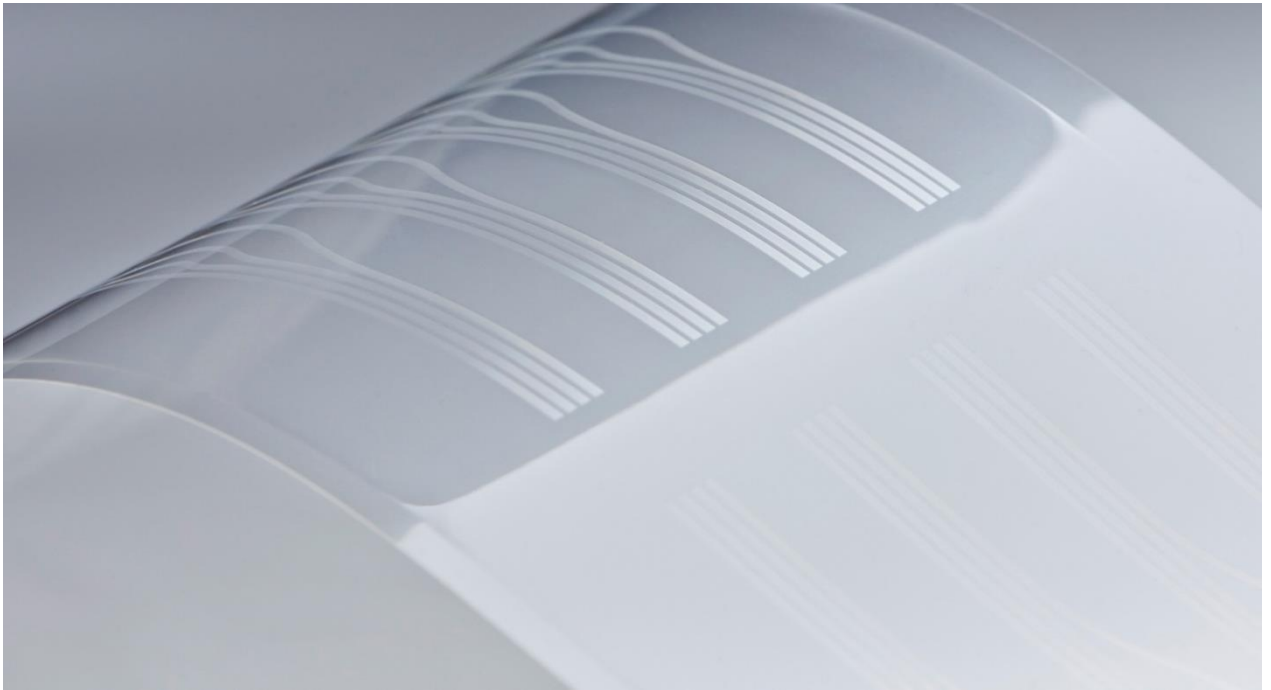

**High density
pattern**

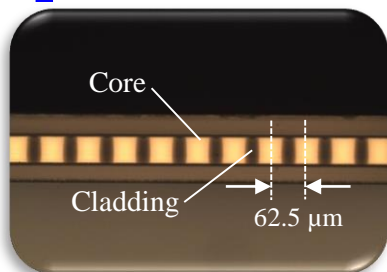

**Flexible
structure**

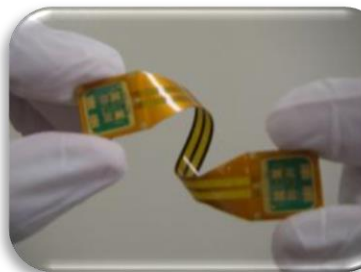

**Easy
assembly**

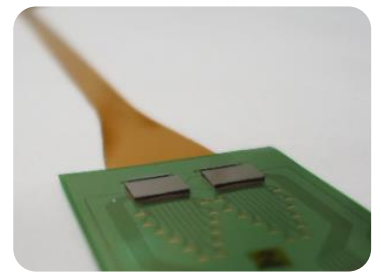

Type 1- Mirror /Connector (Polymer waveguide Type-1)

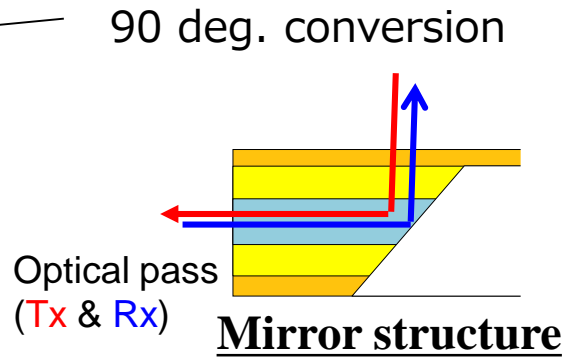
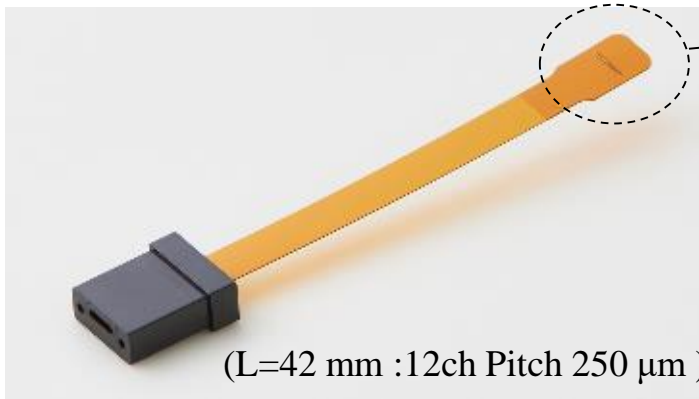

Technical data

Parameters	Values
Insertion loss /Connector: MT coupling /Mirror: active alignment /GI50-MMF	<3.5 dB (Tx/Rx) (Typ. 3.0 dB)
Numerical aperture /Connector side	0.28 (horizontal) 0.32 (vertical)
Inter-channel crosstalk	< -40 dB
Bending loss @ R=5 mm	Stable (< 0.5 dB)
Connection durability (after 100 times)	Stable (< 0.5 dB)
85°C/85% RH test (after 2000 h) *	Stable (< 0.5 dB)
-40°C test (after 500h) *	
-40 ⇄ 85°C test (after 500 cycles) *	

* Compliant with Telcordia GR-468

Type 2- Both side Connector (Polymer waveguide Type-2)

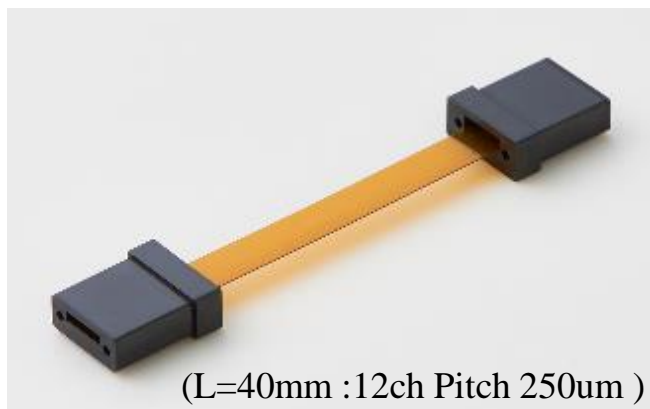

Usage example
For optical transceiver

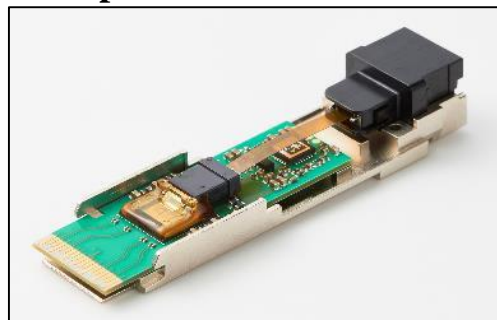

Technical data

Parameters	Values
Insertion loss /Both end : MT-MT	<1.5 dB (Typ.1.0 dB)
Numerical aperture	0.28 (horizontal) 0.32 (vertical)
Inter-channel crosstalk	< -40 dB
Bending loss @ R=5 mm	Stable (< 0.5 dB)
Connection durability (after 100 times)	Stable (< 0.5 dB)
85°C/85% RH test (after 2000 h) *	Stable (< 0.5 dB)
-40°C test (after 500 h) *	
-40 ⇔ 85°C test (after 500 cycles) *	

* Compliant with Telcordia GR-468

External dimensions

Top view

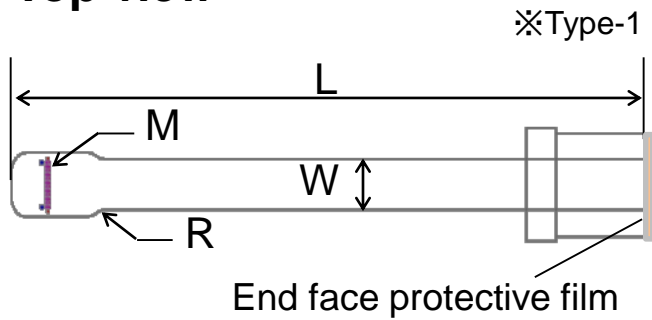

Cross sectional view

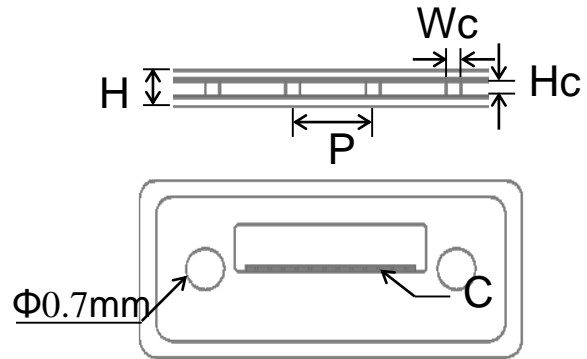

Parameters

Values

(L) Waveguide length	40 mm
(W) Waveguide width	3.1 mm
(M) Mirror position accuracy * with reference to alignment mark	$\pm 5 \mu\text{m}$
(R) Radius of curvature	1 mm

Parameters

Values

(H) Waveguide thickness	102 μm
(Hc) Core thickness	42 μm
(Wc) Core width	48 μm
(P) Core pitch	250 μm
(C) Core position accuracy *with reference to pin-hole	$\pm 5 \mu\text{m}$

Contact us

Department:

Circuitry with optical interconnection (COIN) business Dev. dept.

Address (Sales group):

Tennozu Parkside Building
5-8 Higashi-Shinagawa 2-chome,
Shinagawa-ku, Tokyo, Japan

E-mail:

exh-coin@ml.sumibe.co.jp



Data subject to change without prior notice
Copyright ©2019 Sumitomo Bakelite.